



Thoracic *vanité Cosmic*

Artery Clamps	02
Clamps	04
Bulldog Clamps	09
Scissors	10
Needle Holders	11
Retractors	12
Rib Spreaders	13
Rib Shears	16
Lung Forceps	16
Elevators	17
Miscellaneous	17

Artery Clamps

Outlines

Atraumatic Jaws

- Atraumatic jaws are essential for delicate surgical procedures, minimizing tissue damage while maintaining a firm grip.
- Vanité design strategically reduces the surface area in contact with tissue, which is crucial in sensitive operations like vascular and cardiothoracic surgery.
- Available in both straight and curved forms, atraumatic jaws offer versatility to meet the specific needs of each surgical task.
- The innovation behind atraumatic jaws represents a significant advancement in surgical technology, reflecting a commitment to patient safety and surgical efficacy.

Atraumatic Jaw, Straight



Atraumatic Jaw, Curved



Cooley Artery Clamps

Box joint, atraumatic, curved

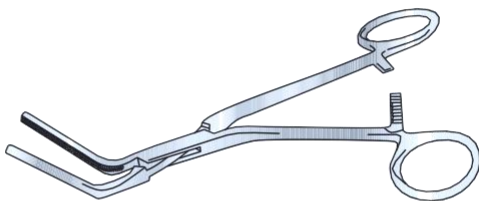

Code	Description
PKTH01071	160mm long
PKTH01072	200mm long

Large, curved 60°

Code	Description
PKTH01073	150mm long

Large, strongly curved 90°

Code	Description
PKTH01074	140mm long

Curved 30°

Code	Description
PKTH01075	160mm long

DeBakey Bainbridge Clamps

Box joint, atraumatic, haemostatic

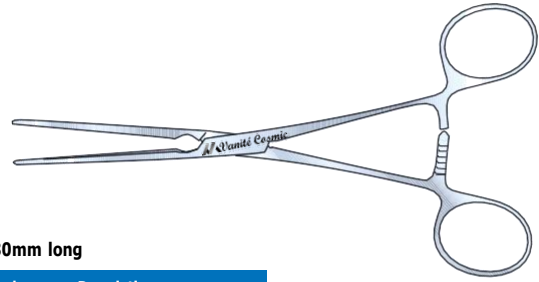

180mm long

Code	Description
PK01SL078	Straight
PK01SL077	Curved

DeBakey Bainbridge Clamps

Box joint, atraumatic

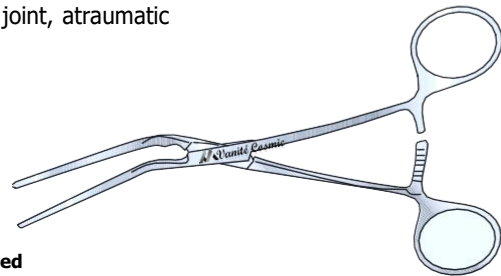

Curved

Code	Description
PKTH01079	165mm long

DeBakey Bainbridge Clamps

Box joint, atraumatic, haemostatic

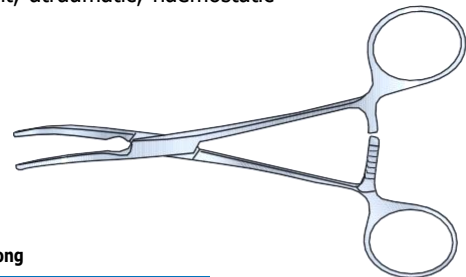

155mm long

Code	Description
PK01SL105	Curved
PK01SL106	Straight

DeBakey Clamps

Box joint, atraumatic

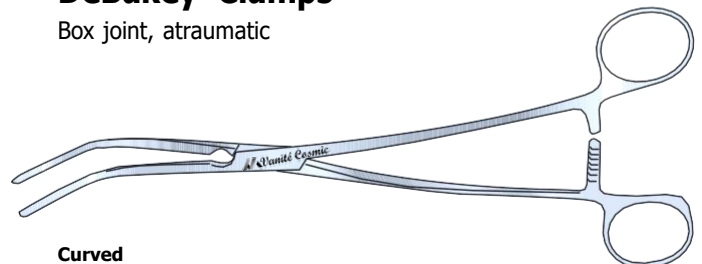

Curved

Code	Description
PKTH01086	230mm long

DeBakey Clamps

Box joint, atraumatic

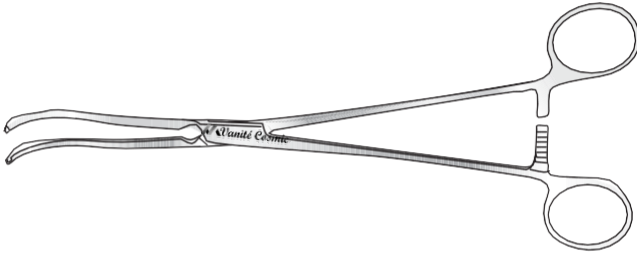

Curved

Code	Description
PKTH01088	230mm long
PKTH01089	240mm long
PKTH01090	245mm long

DeBakey Clamps

Box joint, atraumatic

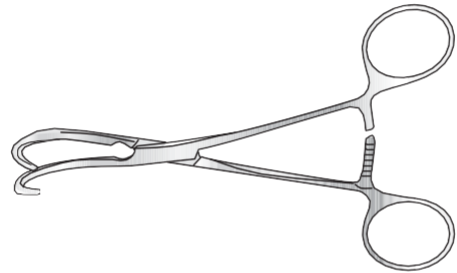

Curved

Code	Description
PKTH01094	150mm long

DeBakey Clamps

Box joint, atraumatic

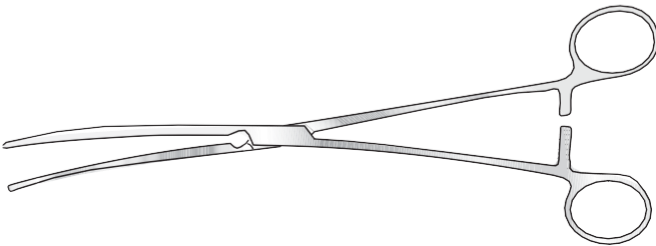

Curved

Code	Description
PKTH01091	250mm long
PKTH01092	270mm long
PKTH01093	280mm long

DeBakey Clamps

Box joint, atraumatic

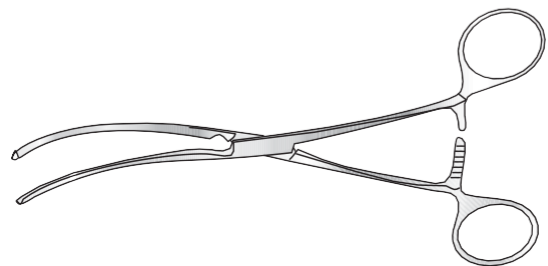

Curved

Code	Description
PKTH01096	180mm long
PKTH01097	203mm long

DeBakey Clamps

Box joint, atraumatic, straight

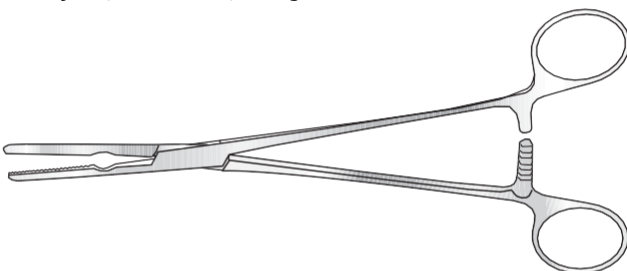

Curved

Code	Description
PK01SL100	160mm long
PK01SL104	165mm long
PK01SL101	203mm long
PK01SL098	215mm long
PK01SL102	220mm long
PK01SL103	230mm long
PK01SL099	245mm long

DeBakey Clamps

Box joint, atraumatic

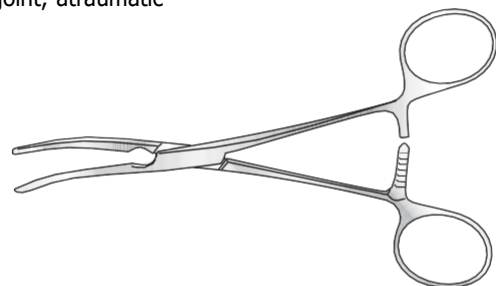

Curved

Code	Description
PK01SC080	165mm long
PK01SC081	190mm long
PK01SC082	203mm long
PK01SC083	215mm long
PK01SC084	220mm long

Clamps

Duval Lung Grasping Clamps

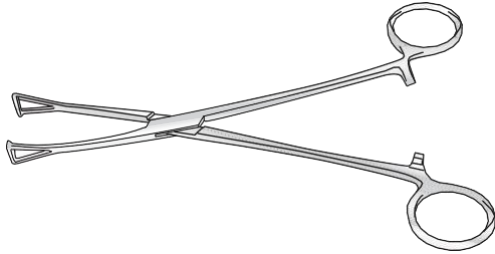

Code	Description
PK01TH0033	185mm long

Tudor Edwards Artery Clamps

Curved, serrated jaws, screw joint, satin finish

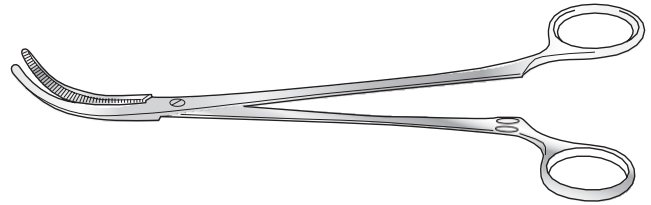

Code	Description
PK01TH0015	230mm long

Babcock Lung Grasping Clamps

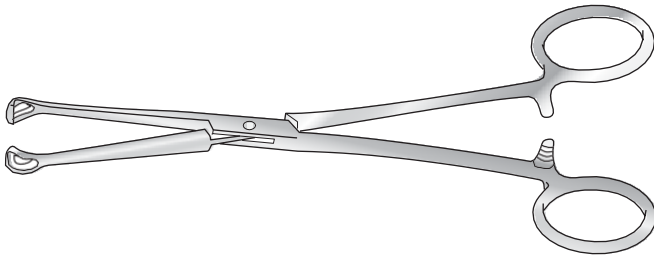

Code	Description
PK01TH0034	245mm long

O'Shaughnessy Artery Clamps

Right angled serrated jaw

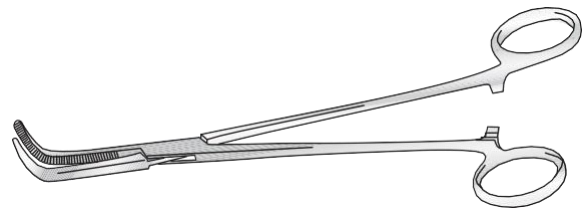

Code	Description
PK01TH0036a	150mm long
PK01TH0036b	180mm long
PK01TH0036c	200mm long
PK01TH0036d	230mm long

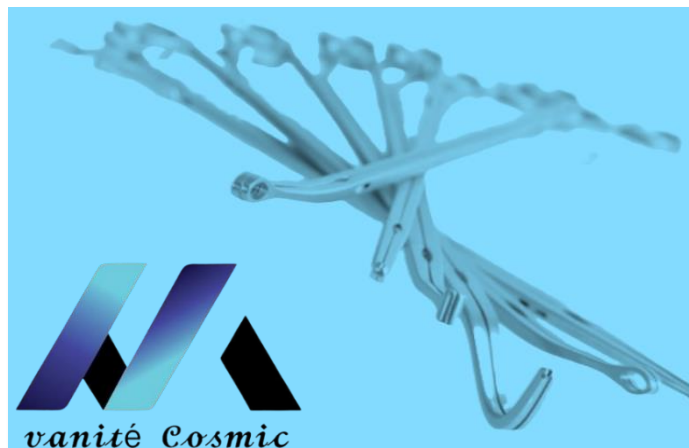

DeBakey Atraumatic Dissecting Clamps

Straight, atraumatic jaws

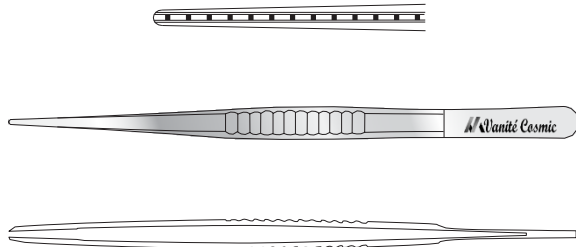

1.5mm

Code	Description
PKTH01238a	150mm long
PKTH01240a	240mm long

2mm

Code	Description
PKTH01238	150mm long
PKTH01241	180mm long

2.5mm

Code	Description
PKTH01238b	150mm long
PKTH01240b	240mm long

2.8mm

Code	Description
PKTH01238c	150mm long
PKTH01240c	240mm long
PKTH01241c	180mm long

Magill Intratracheal Catheter Clamps

Screw joint

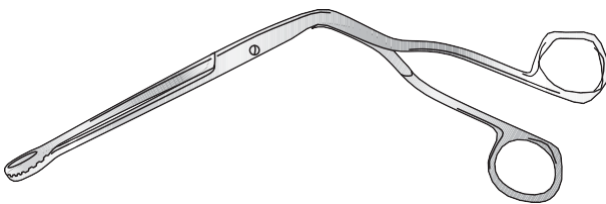

Code	Description
SC-THO/032	Infant, 160mm long
SC-THO/032a	Child, 190mm long
SC-THO/032b	Adult, 230mm long

SEMB Ligature Passing Clamps

240mm long

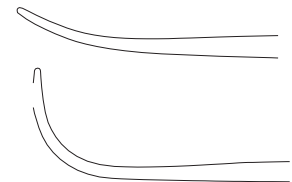
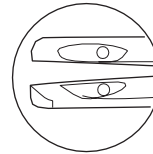
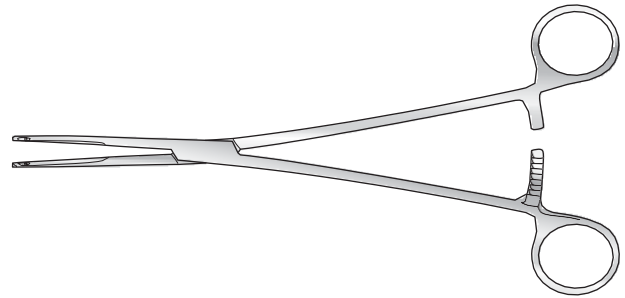

Code	Description
PK01STHO044	Slightly curved
PK01STHO045	Fully curved

Lambert-Kay Clamp

Atraumatic

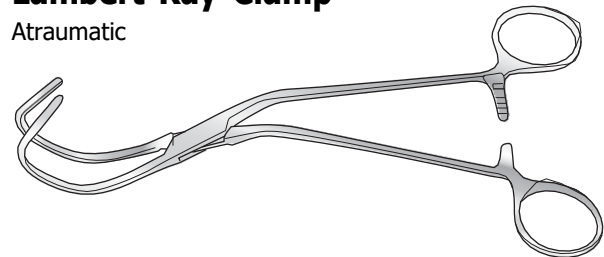

Code	Description
PK01STHO029a	Curved, 220mm long
PK01STHO029b	Straight, 215mm long
PK01STHO029c	Straight, 200mm long

Leland-Jones Clamp

Atraumatic, hemostatic

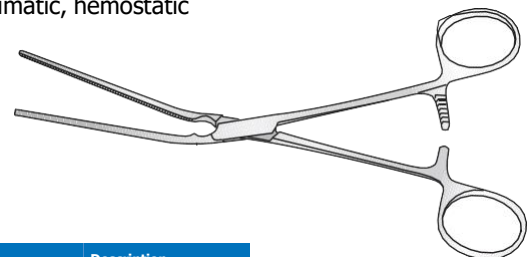

Code	Description
PK01STHO023a	Curved, 190mm long
PK01STHO023b	Straight, 195mm long

Clamps

DeBakey Clamp

Straight jaws, ring handle

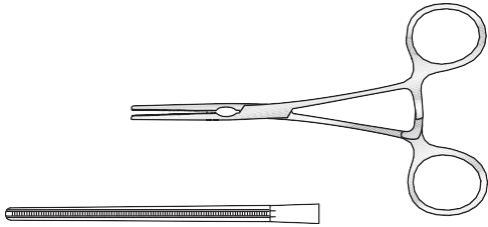

Code	Description
PK01CP048	137mm long

DeBakey Clamp

'S' shaped curved jaws, curved shaft, ring handle

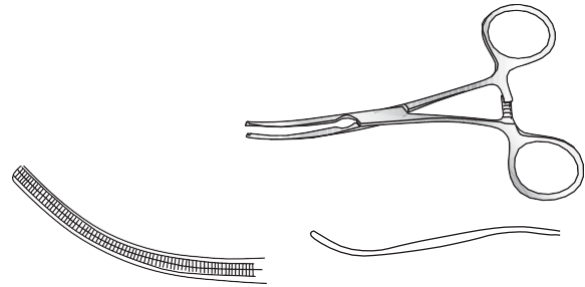

Code	Description
PK01CP049	127mm long

DeBakey "S" Shaped Clamp

300mm long

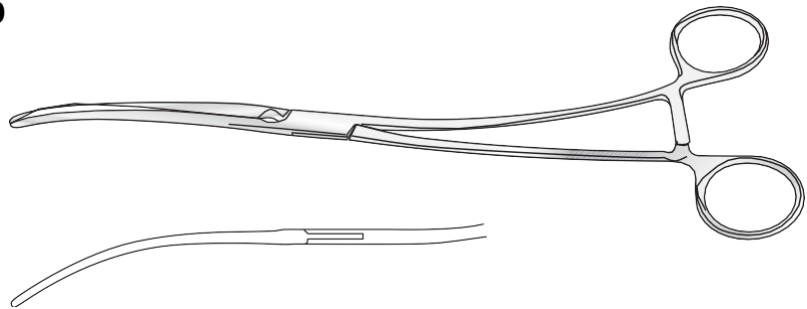

Code	Description
PK01CP096	115mm jaws

DeBakey Atraumatic Clamp

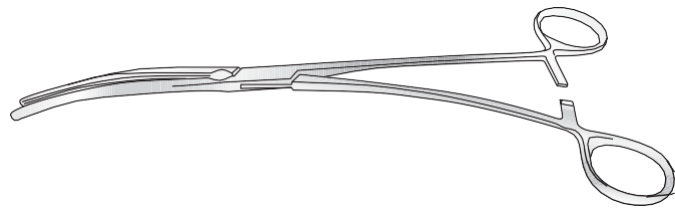

Code	Description
PK01CP090	110mm jaw, 300mm long
PK01CP092	95mm jaw, 250mm long

DeBakey Atraumatic Clamp

Right-angled, 40mm jaw

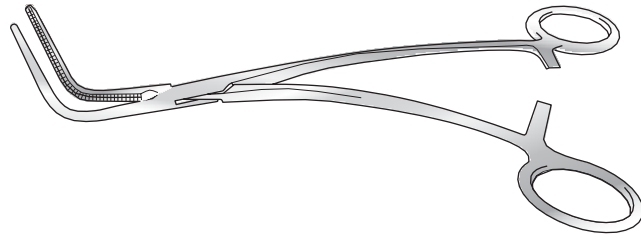

Code	Description
PK01STHO044a	220mm long

DeBakey Atraumatic Clamp

Right-angled, 50mm jaw

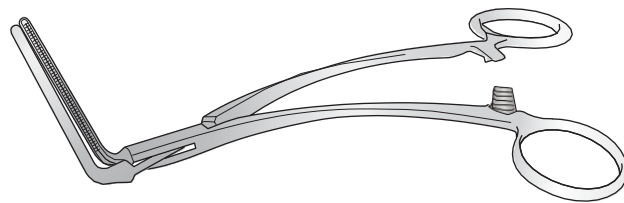

Code	Description
PK01STHO045	200mm long

DeBakey Atraumatic Clamp

Right-angled, 65mm jaw

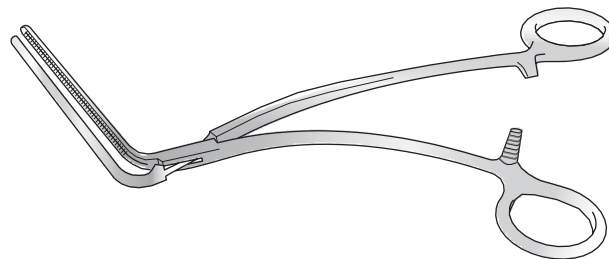

Code	Description
PK01STHO046	215mm long

DeBakey Atraumatic Clamp

Right-angled, 100mm jaw

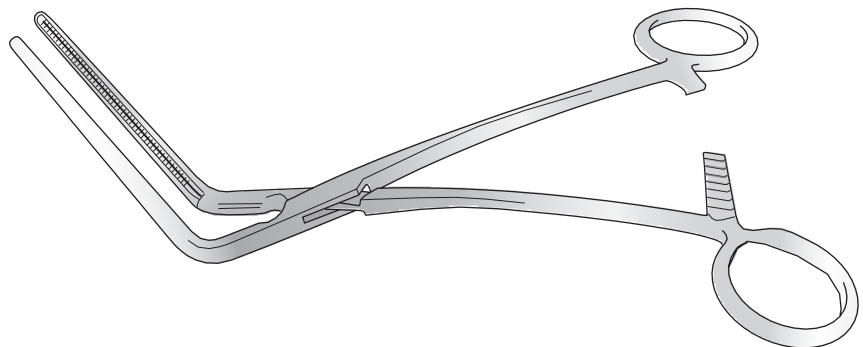

Code	Description
PK01STHO047	280mm long

Clamps

DeBakey Coarctation Clamp

Angled, 225mm long

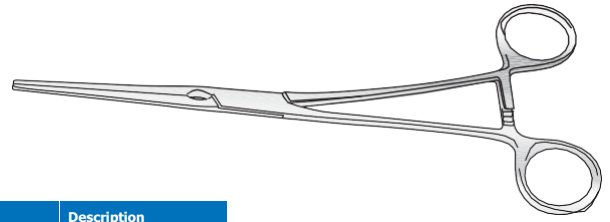
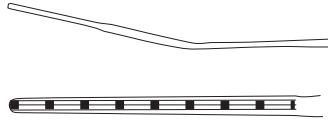

Code	Description
PK01CP052	2225mm long

DeBakey Multipurpose Clamp

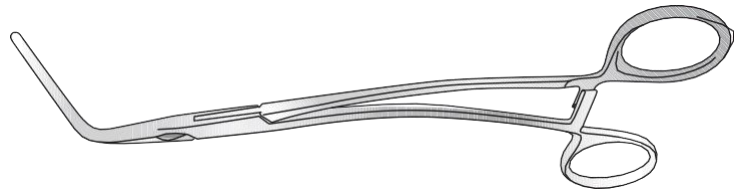
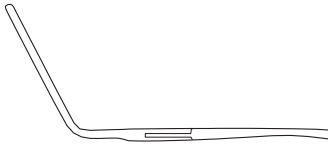

Code	Description
PK01STHO095	85mm jaw, 230mm long
PK01STHO064	100mm jaw, 280mm long

DeBakey Multipurpose Clamp

Obtuse angled 60°, 280mm long

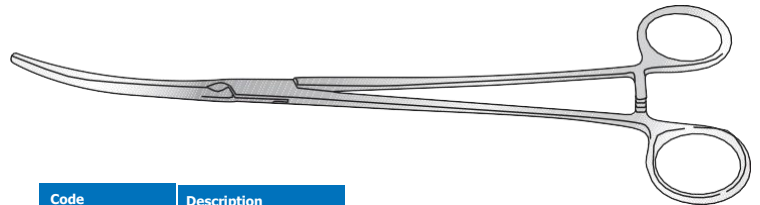
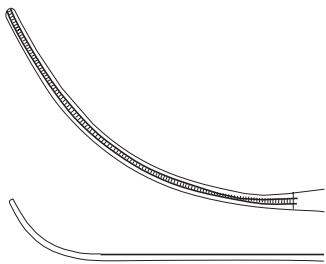

Code	Description
PK01CP053	280mm long

DeBakey 45° Paediatric Clamp

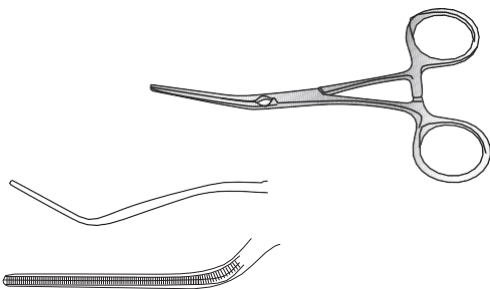

Code	Description
PK01CP050	130mm long

DeBakey 90° Paediatric Clamp

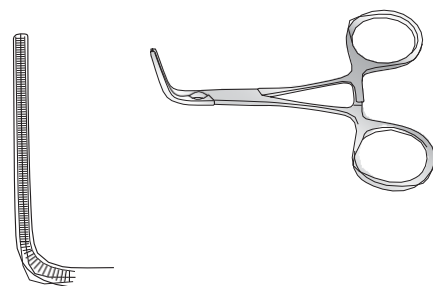

Code	Description
PK01CP051	105mm long

Dieffenbach Bulldog Clamp

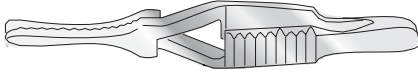

Straight, serrated

Code	Description
PK01CP112	1.2mm fine jaw, 40mm long
PK01CP113	1.2mm fine jaw, 45mm long
PK01CP108	1.8mm jaw, 30mm long
PK01CP109	1.8mm jaw, 35mm long
PK01CP110	2.5mm jaw, 40mm long
PK01CP111	2.5mm jaw, 45mm long
PK01CP107	6mm heavy jaw, 60mm long
PK01CP455	20mm jaw, 75mm long
PK01CP455a	30mm jaw, 85mm long
PK01CP455b	45mm jaw, 105mm long
PK01CP455c	65mm jaw, 120mm long

Straight, plain

Code	Description
PK01CP129	1.2mm fine jaw, 40mm long
PK01CP131	1.2mm fine jaw, 45mm long
PK01CP121	1.8mm jaw, 30mm long
PK01CP123	1.8mm jaw, 35mm long
PK01CP125	2.5mm jaw, 40mm long
PK01CP127	2.5mm jaw, 45mm long

Curved, serrated

Code	Description
PK01CP119	1.2mm fine jaw, 40mm long
PK01CP120	1.2mm fine jaw, 45mm long
PK01CP115	1.8mm jaw, 30mm long
PK01CP116	1.8mm jaw, 35mm long
PK01CP117	2.5mm jaw, 40mm long
PK01CP118	2.5mm jaw, 45mm long
PK01CP114	6mm heavy jaw, 60mm long
PK01CP456	20mm jaw, 75mm long
PK01CP456a	30mm jaw, 85mm long
PK01CP456b	45mm jaw, 105mm long
PK01CP456c	65mm jaw, 120mm long

Curved, plain

Code	Description
PK01CP130	1.2mm fine jaw, 40mm long
PK01CP132	1.2mm fine jaw, 45mm long
PK01CP122	1.8mm jaw, 30mm long
PK01CP124	1.8mm jaw, 35mm long
PK01CP126	2.5mm jaw, 40mm long
PK01CP128	2.5mm jaw, 45mm long

Blalock Bulldog Clamp



Diethrich Bulldog Clamp

Angled 12mm jaw

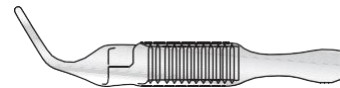

Serrated, with hole in handle

Straight

Code	Description
PKTH01480	11mm jaw, 38mm long
PKTH01482	14mm jaw, 48mm long
PKTH01493	17mm jaw, 60mm long
PKTH01481	27mm jaw, 70mm long

Curved

Code	Description
PKTH01478	11mm jaw, 38mm long
PKTH01479	14mm jaw, 48mm long
PKTH01491	17mm jaw, 60mm long
PKTH01492	27mm jaw, 70mm long

Code	Description
PK01CP8097	44mm long

Plain, with hole in handle

Straight

Code	Description
PK01CP486	11mm jaw, 38mm long
PK01CP487	14mm jaw, 48mm long
PK01CP488	17mm jaw, 60mm long
PK01CP489	27mm jaw, 70mm long

Curved

Code	Description
PK01CP483	11mm jaw, 38mm long
PK01CP484	14mm jaw, 48mm long
PK01CP485	17mm jaw, 60mm long
PK01CP490	27mm jaw, 70mm long

Scissors

Potts Scissors

Satin finish, 190mm long

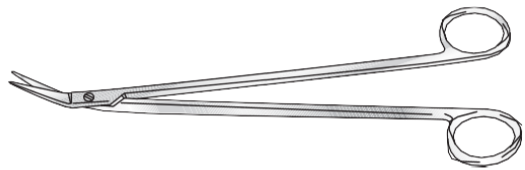

Code	Description
PK01AS019	Angled on flat 45°
PK01AS020a	Angled to side 45°
PK01AS020b	Acute angle to side

Potts Diethrich Scissors

Supercut, 190mm long

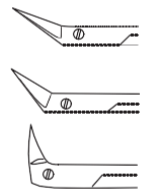

Code	Description
PK01AS078	25° angled on side
PK01AS079	45° angled on side
PK01AS080	90° angled on side

Diethrich Circumflex Artery Scissors

Supercut, 175mm long



Code	Description
PK01TH0077	125° angled on side

Boyd Scissor

Supercut, slight curve

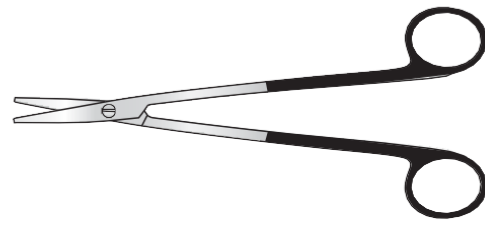

Code	Description
PK01TH0047	180mm long

Lobectomy Scissors

Curved on flat

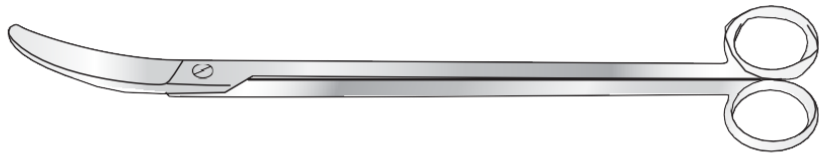

Code	Description
PK01STH0001b	305mm long

Nelson Lobectomy Scissor

Tungsten carbide, curved on flat, 230mm long

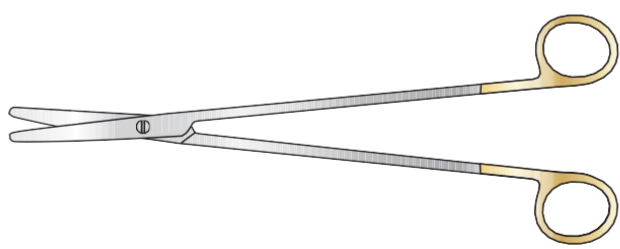

Code	Description
PK01STH00057	230mm long

Needle Holder and Wire Twister

For sternum wire, left-handed, 300mm long

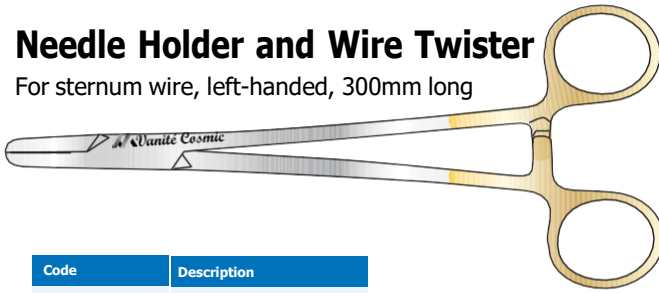

Code	Description
PK01THO083	300mm long, LH

Julian Needle Holder

Light, delicate model, with tungsten carbide jaws
220mm long

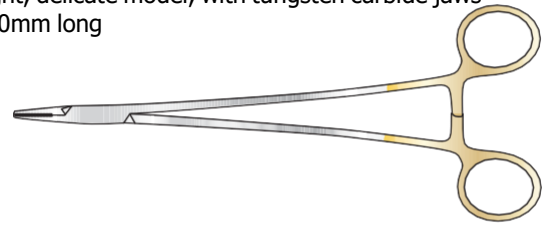

Code	Description
PK01THO081	Left-handed
PK01THO081a	Left-handed

Rochester Needle Holder

Light, delicate model, with tungsten carbide jaws

190mm long

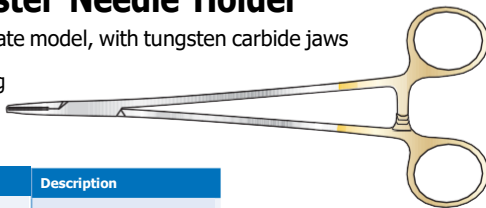

Code	Description
PK01THO082	Right-handed
PK01THO082a	Left-handed

DeBakey Needle Holder

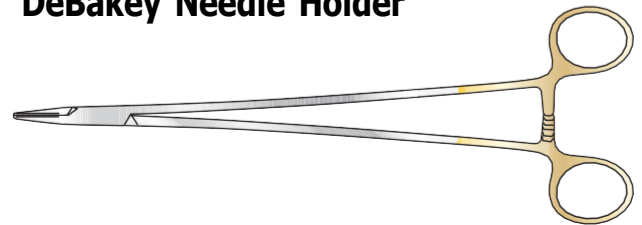

Stratte Needle Holder

210mm long

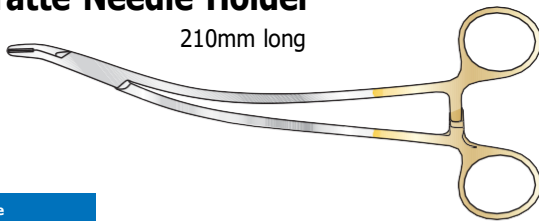

Code
PK01STH5642b

Code	Description
PK01SO5642a	250mm long
PK01GI502A	165mm very delicate
PK01GI502	180mm tungsten carbide
PK003944	260mm long straight with tungsten carbide inserts
PK015642A	240mm long
PK01GI0368M	Tungsten carbide delicate 230mm long
PK01-GI0378M	Tungsten carbide delicate 250mm long
PK01GI0388M	Tungsten carbide delicate 305mm long

Castroviejo Needle Holder

Code	Description
PK01OP021	140mm long, with catch
PK01OP020	140mm long, without catch

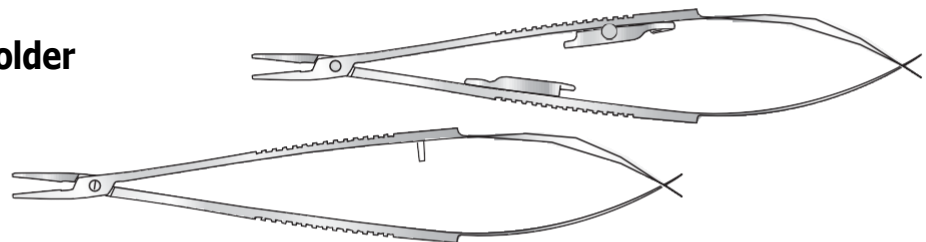

Diamond dust jaws

Code	Description
PK01STH060	180mm long, without catch
PK01STH061	200mm long, without catch
PK01STH062	215mm long, without catch

ALSO AVAILABLE WITH CATCH - ADD SUFFIX CTH TO CODE



Tungsten carbide jaws

Code	Description
PK01STH058a	180mm long
PK01STH058	200mm long
PK01STH059	215mm long

ALSO AVAILABLE WITH CATCH - ADD SUFFIX CTH TO CODE

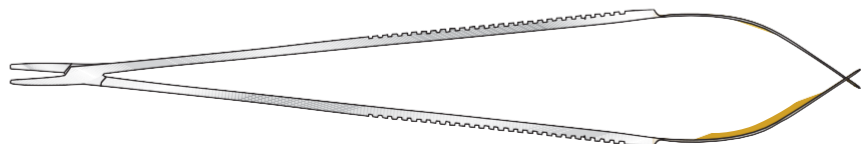

Retractors

Blanco Valve Leaflet Retractor

280mm long



Code
PK01STH041

Harrington Splanchnic Retractor

Small size, end of blade
38mm wide x 127mm deep
satin finish handle

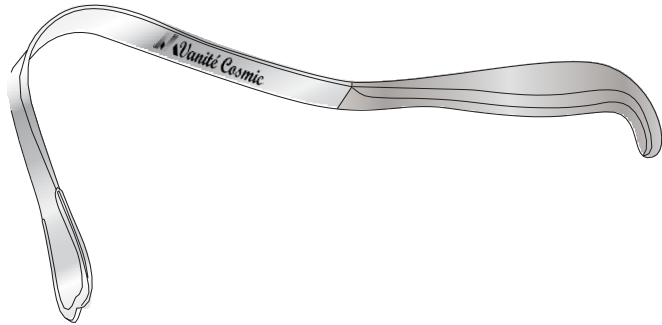

Code	Description
PK01STH011	320mm long

Brocks Erecton Spinal Back End Retractor

215mm long

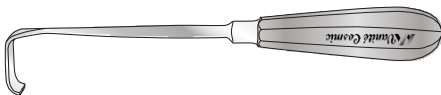

Code	Description
PK01STH054	13 x 28mm

Cleland Valve Leaflet Retractor

250mm long



Code	Description
PK01STH097	250mm long

Ross Retractor

250mm long

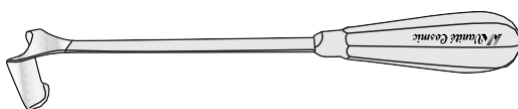

Code	Description
PK01STH089	16mm x 15mm blade
PK01STH089a	23mm x 13mm blade
PK01STH089b	24mm x 16mm blade

Code	Description
PK01STH089c	27mm x 13mm blade
PK01STH089d	27mm x 27mm blade
PK01STH089e	25mm x 38mm blade

Tudor Edwards Retractor

25mm Wide

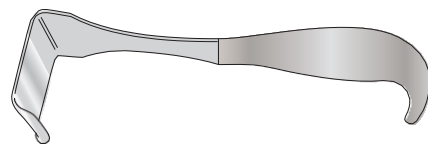

Code	Description
PK01STH013	205mm long

Allison Lung Retractor

Satin finish handle

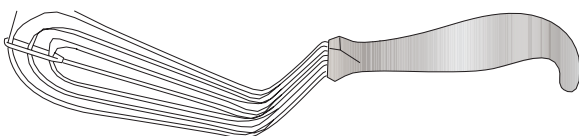

Code	Description
PK01STH012a	Infant
PK01STH012b	Child, 280mm blade
PK01STH012c	Adult, 300mm blade

Cooley Atrial Retractor

260mm overall length

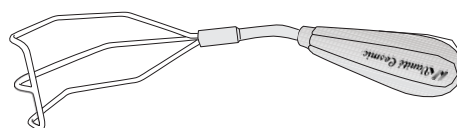

Code	Description
PK01STH046	Right
PK01STH046a	Left

Rib Spreaders

Finochietto Rib Spreader

Straight arms, 20mm square blades

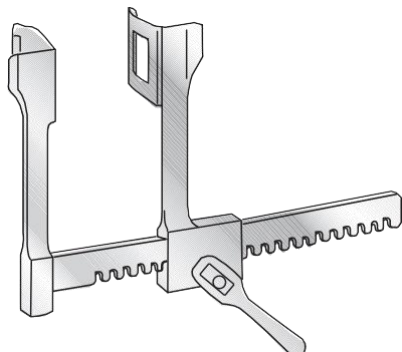

Code	Description
PK01STH006	Infant, maximum opening 80mm x 60mm long
PK01STH037	Adult, maximum opening 200mm, blades 44 x 65mm

Morse-Favaloro Rib Spreader

Curved arms, 275mm long

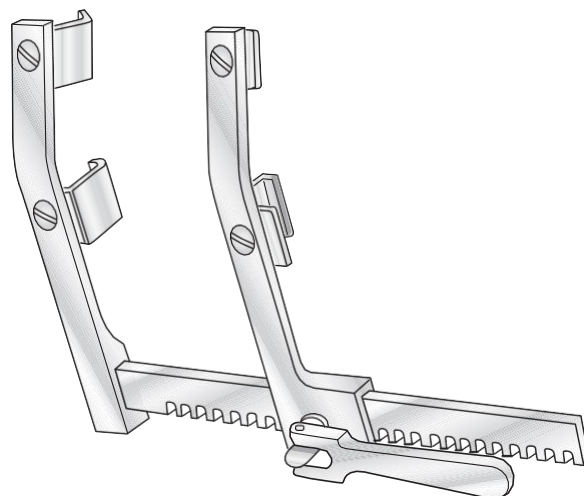

Code	Description
PK01STH103	Swivel blades 215mm long
PK01STH103a	Swivel blades 185mm long

IMA Rib Spreader

Converts left or right

Code	Description
PK01STH0102	Standard frame only
PK01STH0102a	Ministernotomy frame only
PK01STH0102b	Complete, standard, 1 x frame, 1 x 100mm long x 20mm wide U shaped blade, 1 x claw blades 28mm and 32mm deep
PK01STH0102c	Complete, ministernotomy, 1 x frame, 1 x 30mm long x 20mm wide U shaped blade, 1 x claw blades 43mm and 50mm deep

Claw blade only

Code	Description
PK01STH102d	28mm deep
PK01STH102e	32mm deep
PK01STH102f	38mm deep
PK01STH102g	43mm deep
PK01STH102h	50mm deep

U shaped blade only

Code	Description
PK01STH102i	100mm long x 20mm wide
PK01STH102j	100mm long x 25mm wide
PK01STH102k	30mm long x 20mm wide

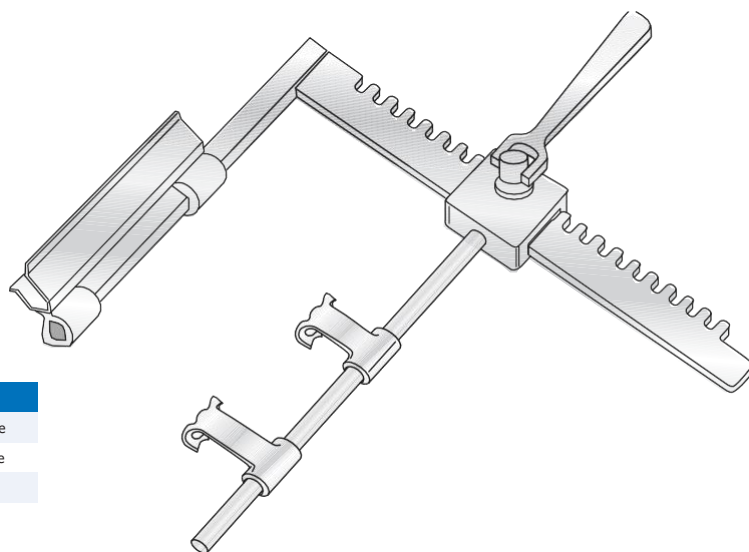

Price Thomas Rib Spreader

Code	Description
PK01STH099	Complete with 3 pairs of blades, key, 250, 215, 68mm
PK01STH099a	Blade only, 50mm x 38mm, pair
PK01STH099b	Blade only, 50mm x 45mm, pair
PK01STH099c	Blade only, 50mm x 65mm, pair
PK01STH099d	Nut and bolt for blade only
PK01STH099e	Frame only
PK01STH099f	Key only

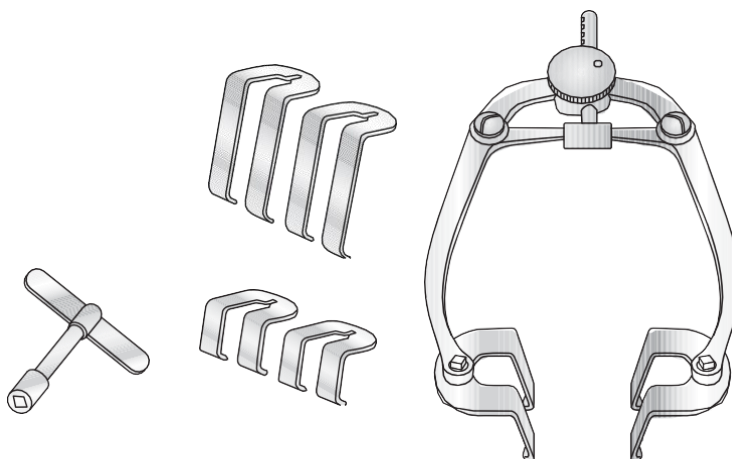

Rib Spreaders

Sellers Rib Spreader

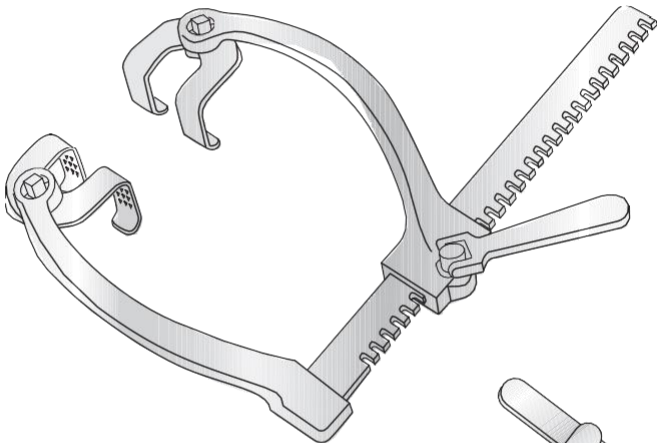

Code	Description
PK01STH100	Complete with 3 pairs of blades, key,
PK01STH100a	Blade only, 50mm x 38mm, pair
PK01STH100b	Blade only, 50mm x 45mm, pair
PK01STH100c	Blade only, 50mm x 65mm, pair
PK01STH100d	Frame only
PK01STH100e	Nut and bolt for blade only
PK01STH100f	Key only

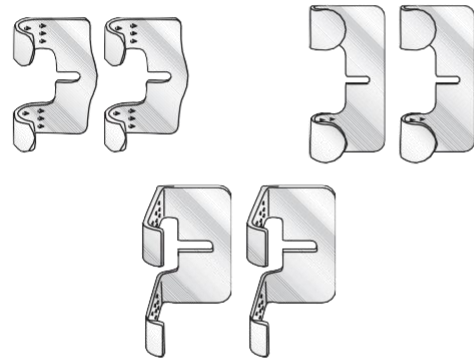
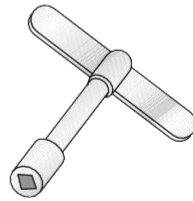

Harefield sternal blade only, pair

Code	Description
PK01STHO100g	70 x 30mm
PK01STHO100h	120 x 30mm

Harefield scapula blade only, pair

Code	Description
PK01STH100i	75 x 70mm

Ronald Edwards Rib Spreader

Curved arms, fenestrated

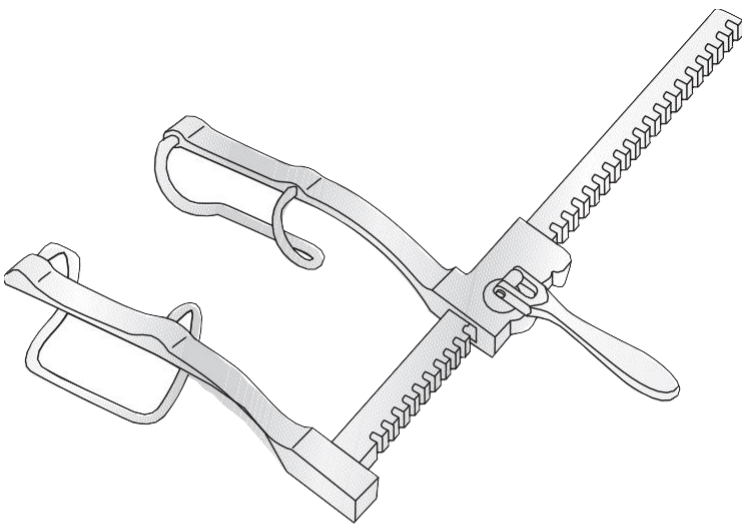

Code	Description
PK01STHO104	Infant, 100mm, 25mm x 30mm blades
PK01SH5158	Child, 150mm, 30mm x 50mm blades
PK01SH5720	Adult, 245mm, 65mm x 75mm blades

Bailey Rib Approximator and Spreader

Combined, satin finish

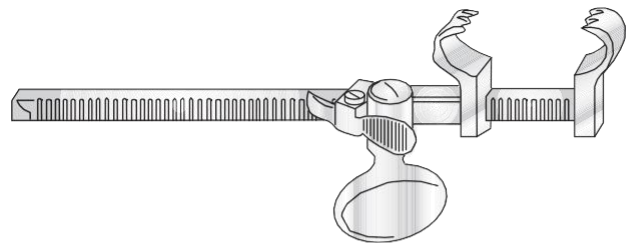

Code	Description
PK01STHO003	160mm long

Sellers Rib Approximator and Spreader

Combined action, satin finish

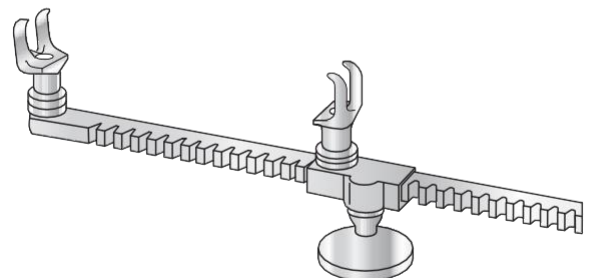

Code	Description
PK01STHO002	195mm long

Cooley Rib Spreader

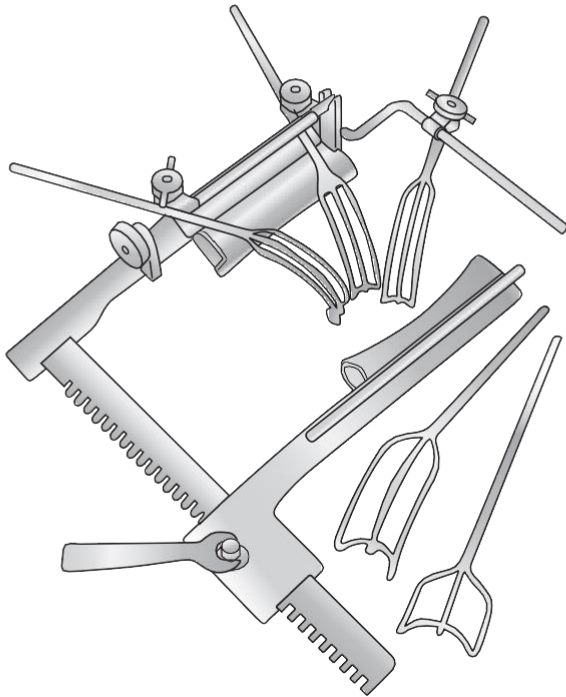

Code	Description
PKS4395050	Adult, 40mm x 110mm blades, complete with cosgrove mounting bars
PKS4395090	Adult, 40mm x 110mm blades, complete with cosgrove mitral valve retractor attachment, 5 x blades, 3 x clamp, 1 x side arm

Wells Rib Spreader

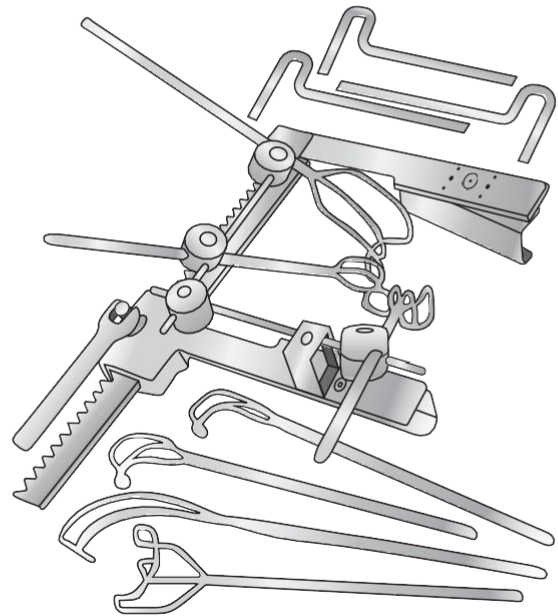

Code	Description
PK0192080-65	Small rake retractor on shaft
PK0192080-80	Frame only, 90mm wide x 25mm deep blades
PK0192080-90	Complete, frame, pillar clamp, 4 x ball clamps, 2 x mounting bars, hex keys, 1 x tricuspid rake ret, 2 x small, medium and large rake ret

Tudor Edwards Rib Spreader

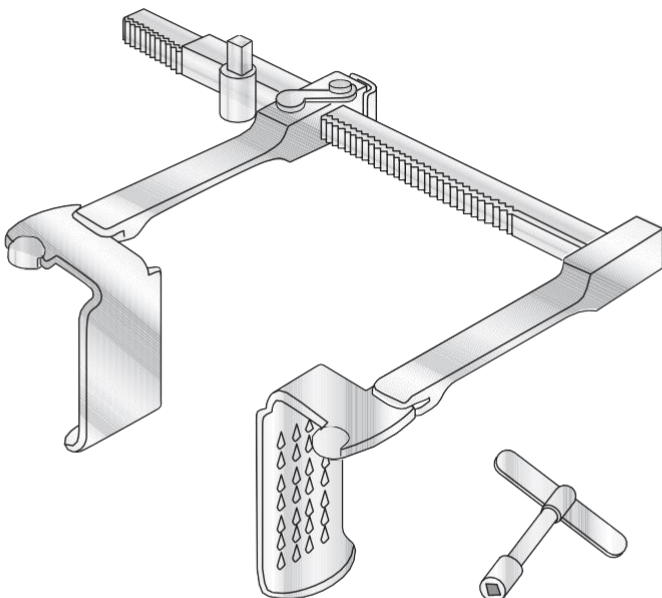

Code	Description
PK01STHO101	Complete, 2 of each blade, plus key
PK01STHO101a	25mm blade only, pair
PK01STHO101b	50mm blade only, pair
PK01STHO101c	75mm blade only, pair

Tuffier Rib Spreader

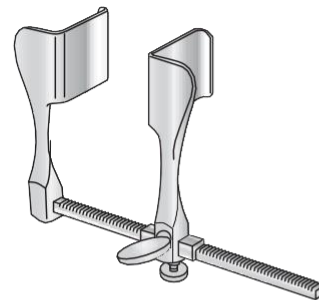

Code	Description
PK01STHO005	Blades 25mm deep x 19mm wide

Vehmehren Rib Holder and Costotome

Satin finish handles

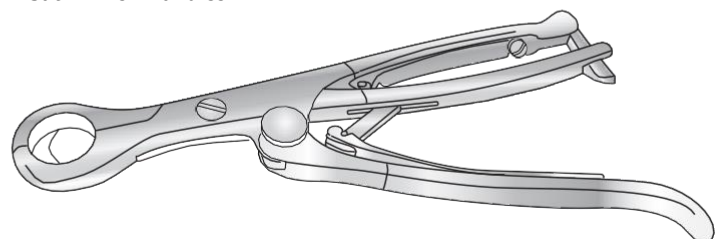

Code	Description
PK01THO010	240mm long

Rib Shears and Lung Forceps

Giertz Rib Shears

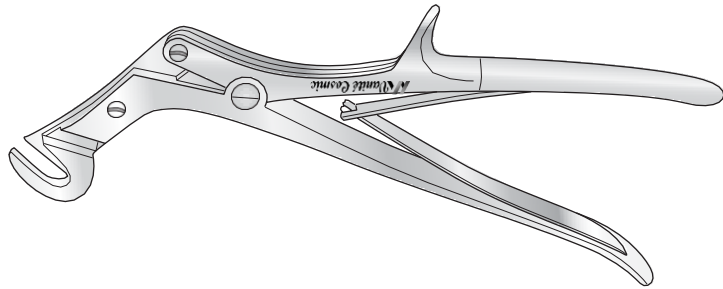

Code	Description
PK01STHO041	270mm long

Tudor Edwards Rib Shears

Compound action, anterior

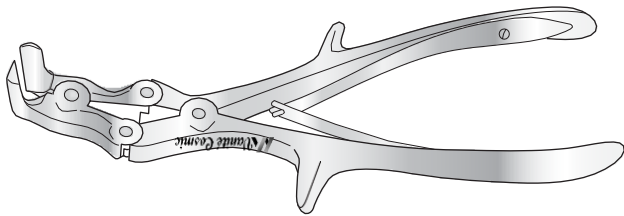

Code	Description
PK01STHO042	235mm long

Mayo Lung Forceps

Fenestrated, semi-circular jaw, satin finish



Code	Description
PK01THO014	230mm long

Special Care Needed For Your Surgical Instruments

Staining



Remember Saline can indeed be corrosive to surgical instruments if they are not promptly and properly cleaned after use. This not only compromises the integrity of the instruments but can also interfere with their sterilization.

Caring



Tudor Edwards Periosteal Elevator

First rib, 175mm long

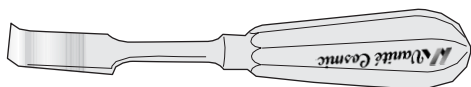

Code	Description
PK01STHO09b	18mm wide

Doyen Periosteal Elevator

Satin finish handle

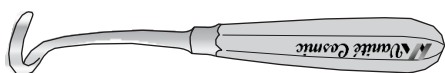

165mm long

180mm long

Code	Description	Code	Description
PK01SRON031	Right	PK01SRO2561	Right
PK01SRON032	Left	PK01SRO2551	Left

Blalock Hook

249mm long



Code	Description
PK01STHO042	45° angle, 5mm tip
PK01STHO043b	90° angle, 5mm tip

Ross (Papworth) Ventricular Sucker

33mm long



Code	Description
PK01STHOPAP001	Bullet

Ross (Papworth) Sump Sucker

42mm long

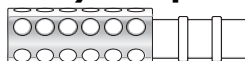

Code	Description
PK01STHOPAP002	Round end

Ross (Papworth) Flat Sucker

42mm long

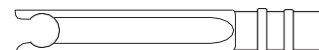

Code
PK01STHPAP003

Ross Probe

200mm long

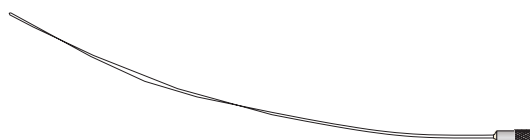

Code	Description
PK01THO055	1mm
PK01THO055a	1.5mm

Tibbs Arterial Cannula

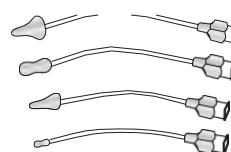

Code	Description
PK01TIB001	Set of four
PK01TIB002	Large cone
PK01TIB003	Large olive
PK01TIB004	Small cone
PK01TIB005	Small olive

GU pattern

Code	Description
PK01TIB006	Large cone
PK01TIB007	Large olive
PK01TIB008	Small cone
PK01TIB009	Small olive
PK01TIB010	Set of four